

SUPER GT 2018 SERIES GT500

Epson Nakajima Racing Epson Modulo NSX-GT

1:24 Scale Paper Craft

Sheet 1

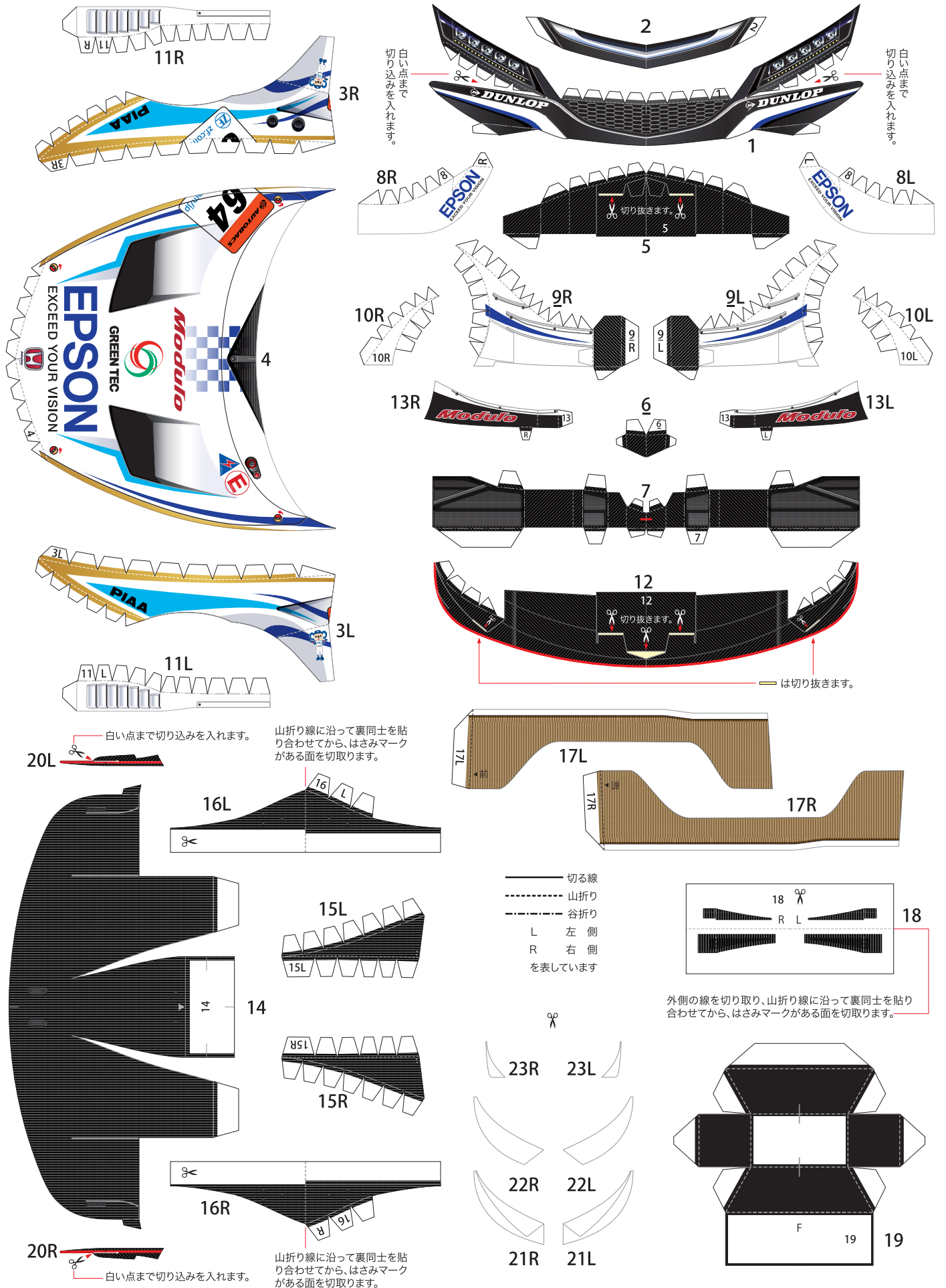

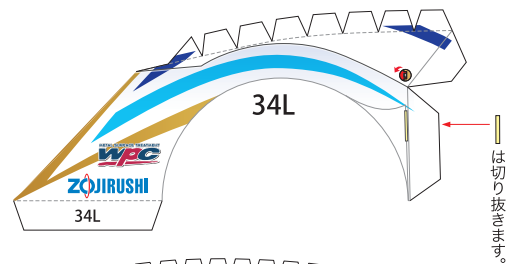
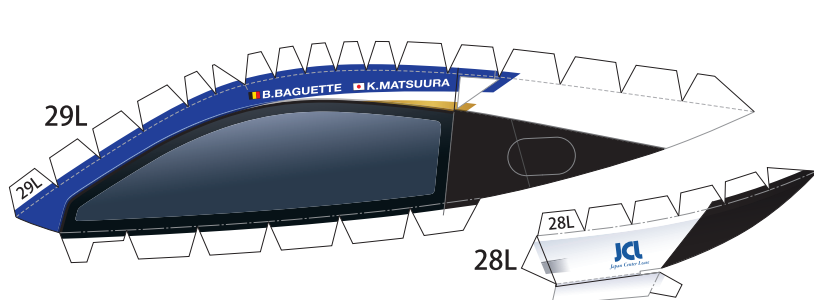
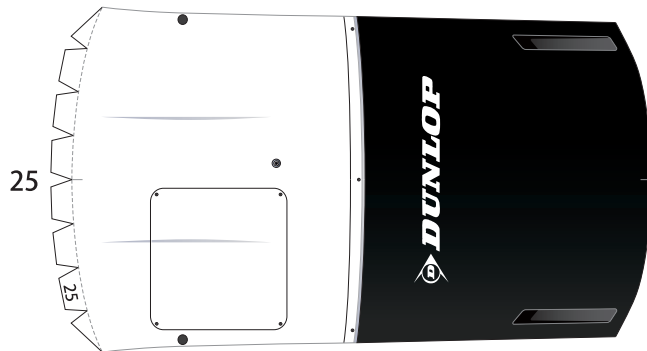
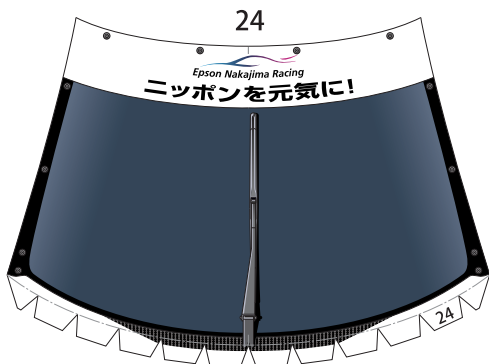

は切り抜きます。



赤い点まで切り込みを入れます。

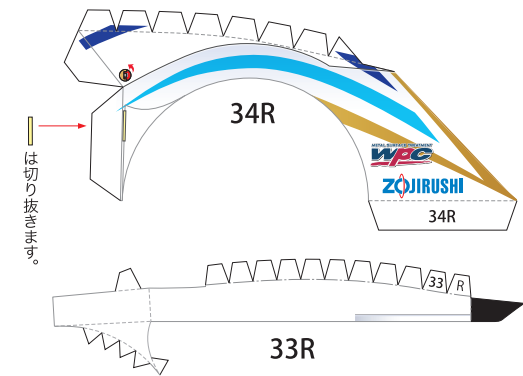
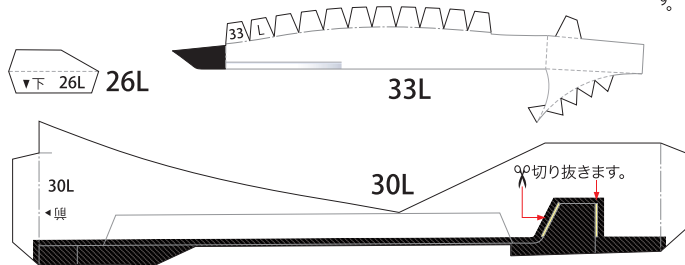

は切り抜きます。

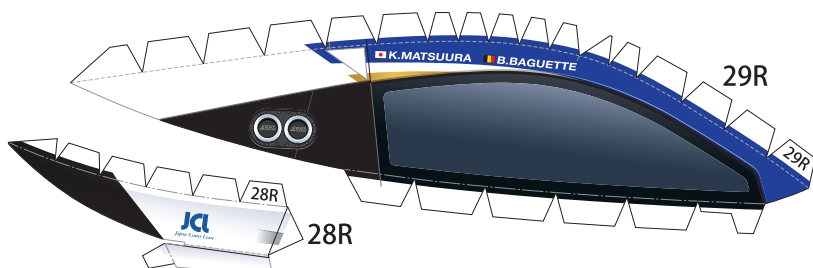

赤い点まで切り込みを入れます。

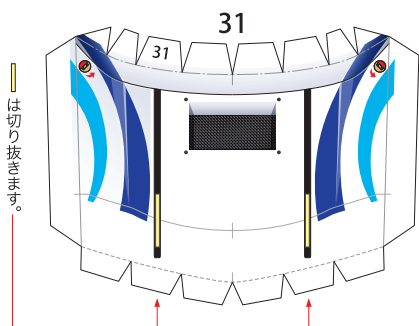
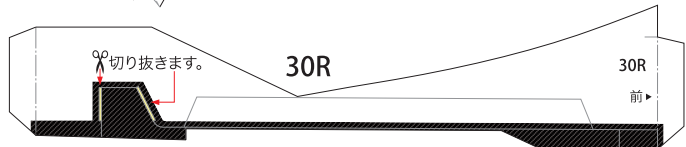

は切り抜きます。

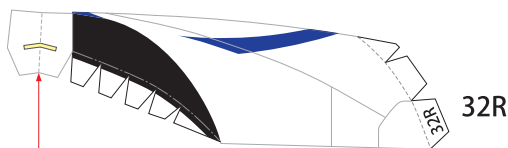

山折り線に沿って裏同士を貼り合わせてから、
部分切り抜きます。

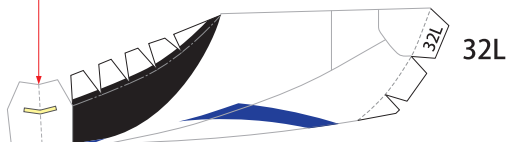

- 切る線
- - - 山折り
- - - 谷折り
- L 左側
- R 右側
- を表しています

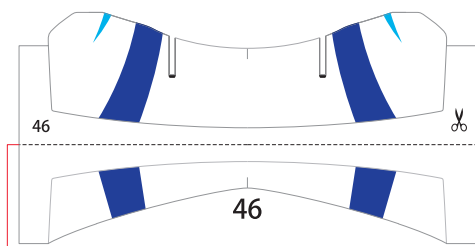
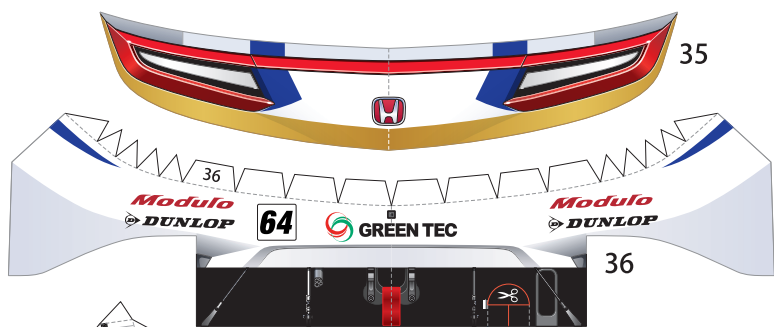

外側の線を切り取り、山折り線に沿って裏同士を貼り合わせてから、はさみマークがある面を切り取ります。

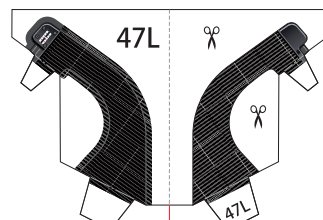
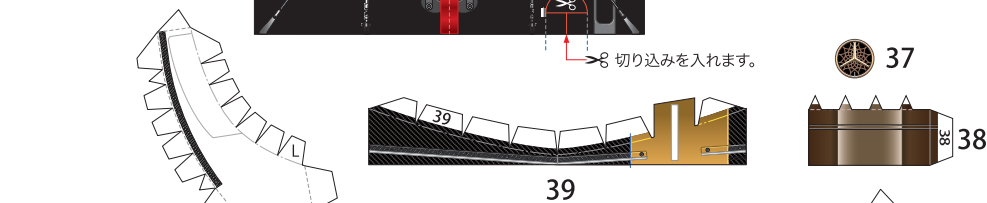

外側の線を切り取り、のりしろ以外の裏同士を山折り線に沿って貼り合わせてから、はさみマークがある面を切り取ります。

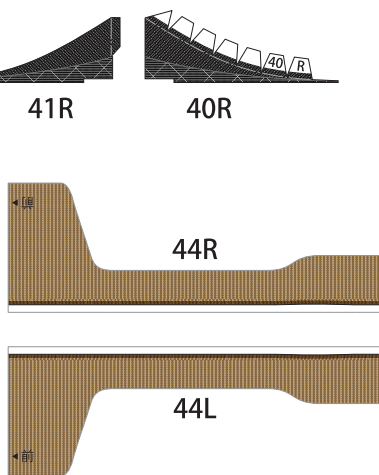
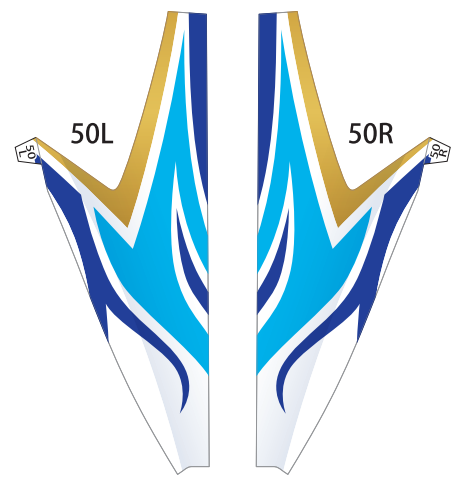
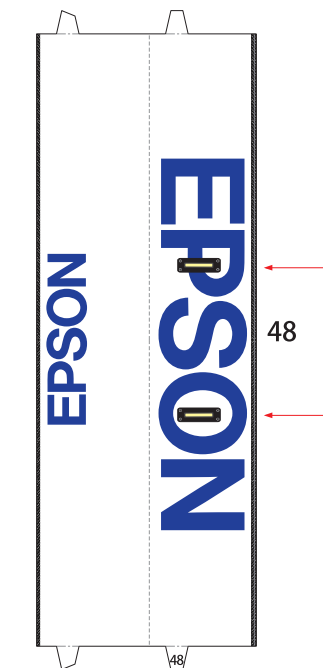
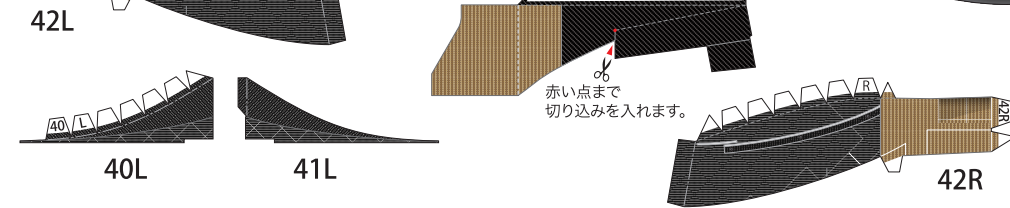
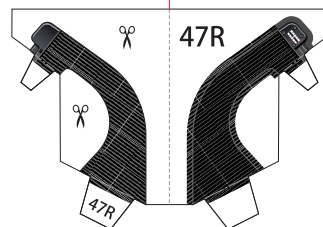
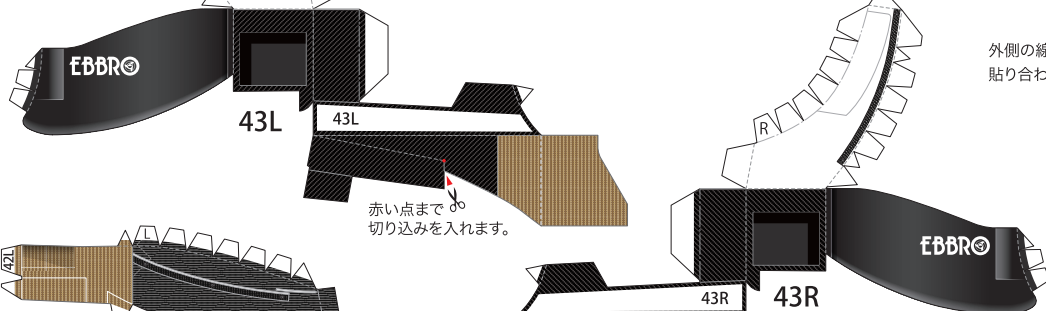

は全て切り抜きます。

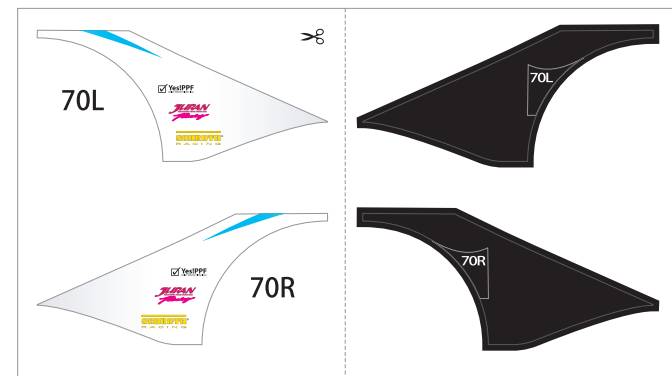

— 切る線
 - - - 山折り
 - - - 谷折り
 L 左側
 R 右側
 を表しています

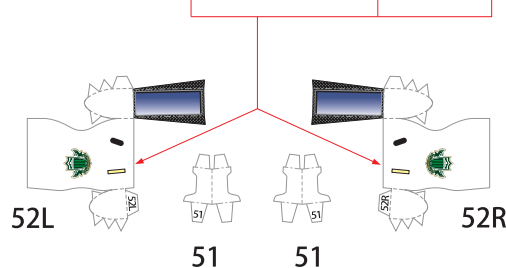

外側の線を切り取り、山折り線に沿って裏同士を貼り合わせてから、はさみマークがある面を切り取ります。

1:24 Scale Paper Craft

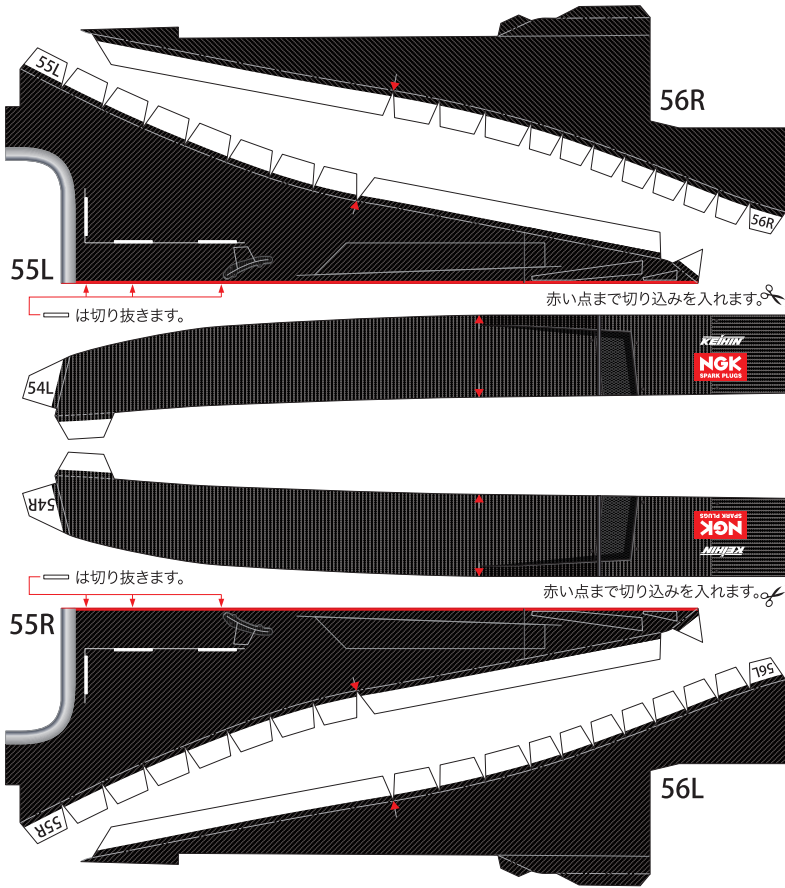

— 切る線
 - - - 山折り
 - - - 谷折り
 L 左側
 R 右側
 を表しています

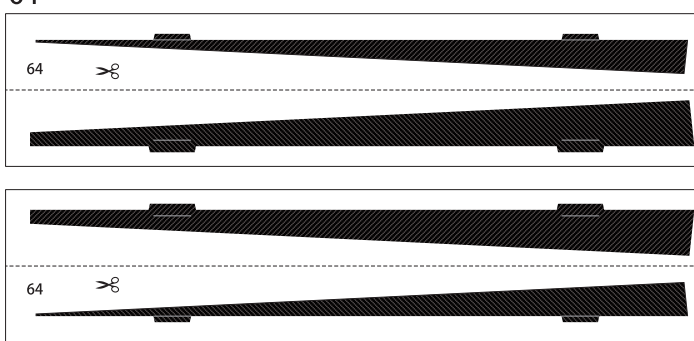
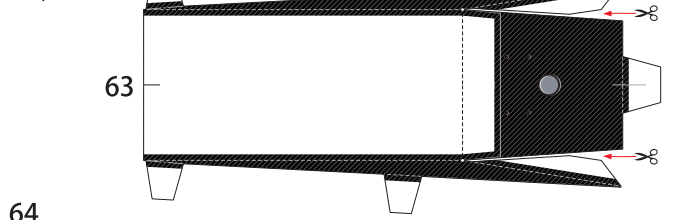
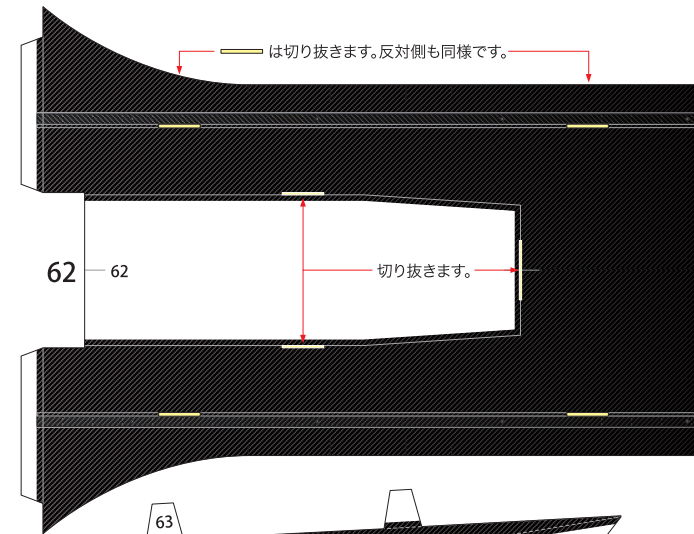
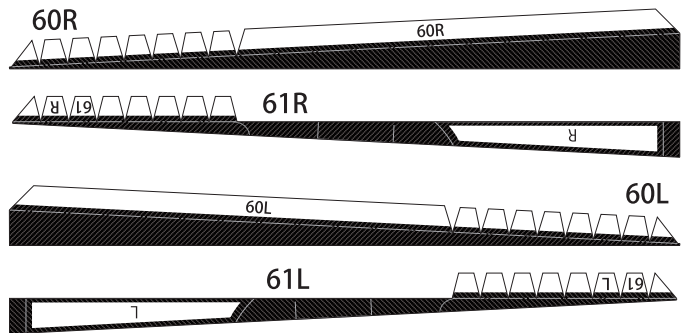
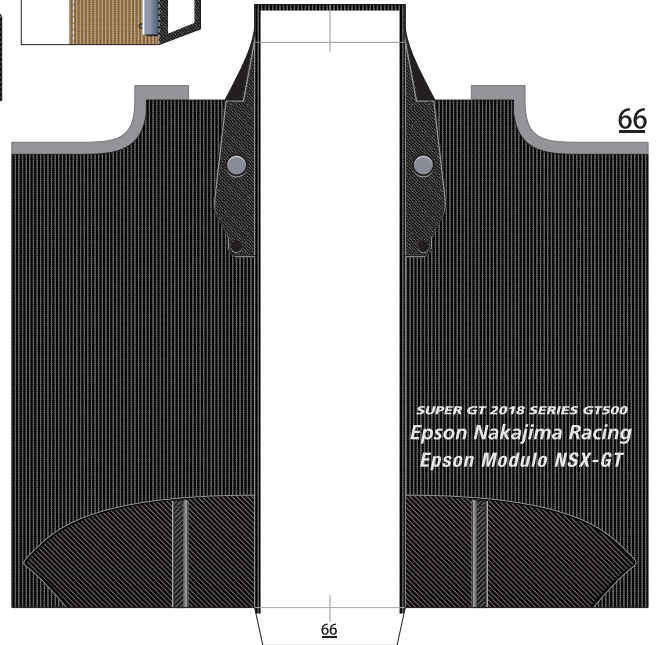
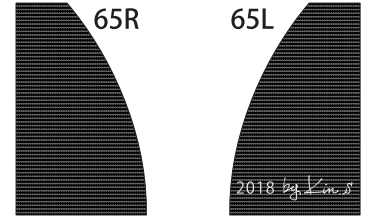
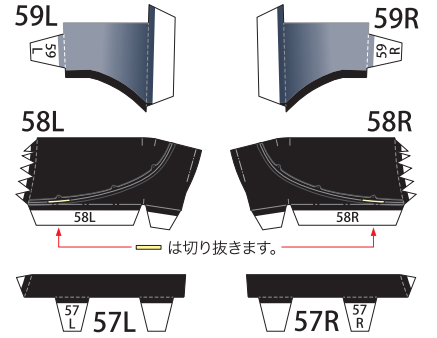

外側の線を切り取り、山折り線に沿って裏同士を貼り合わせてから、はさみマークがある面を切り取ります。

