

# SUPER GT 2014 SERIES GT500

## Epson Nakajima Racing Epson NSX CONCEPT-GT

1:24 Scale Paper Craft

Sheet 1

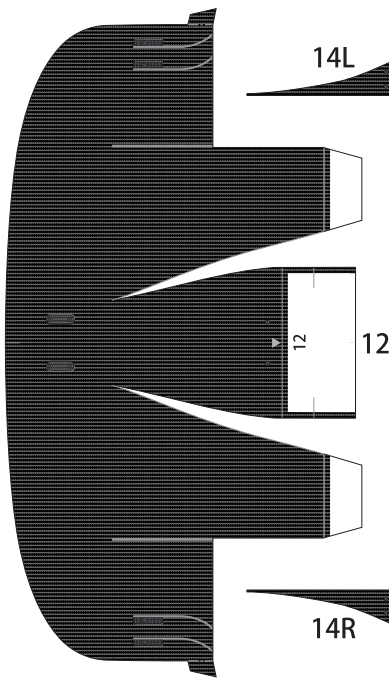
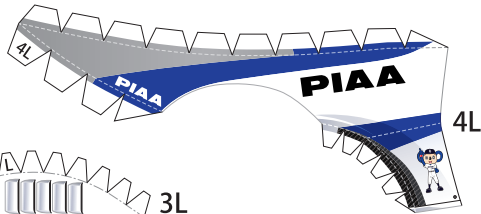
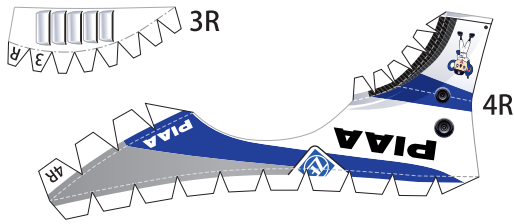

16R



山折り線に沿って裏同士を貼り合わせます

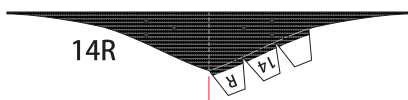
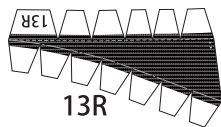
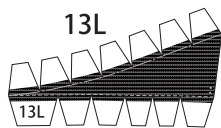

山折り線に沿って裏同士を貼り合わせます

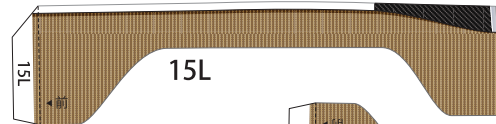
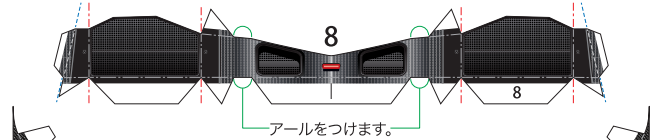
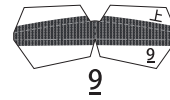
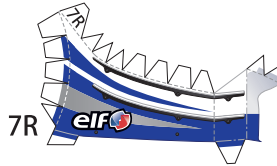

— 切る線  
 - - - 山折り  
 - - - 谷折り  
 L 左側  
 R 右側  
 を表しています

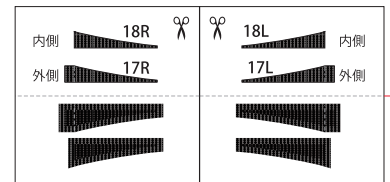

外側の線を切り取り、山折り線に沿って裏同士を貼り合わせてから、はさみマークがある面を切り取ります。

外側の線を切り取り、裏側に紺色に塗りつぶしてから切り抜きます。

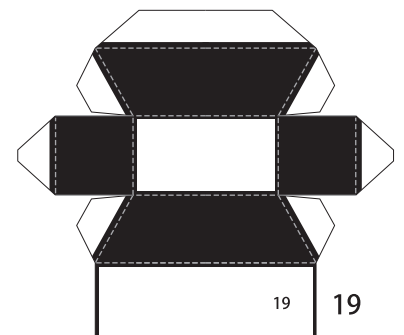
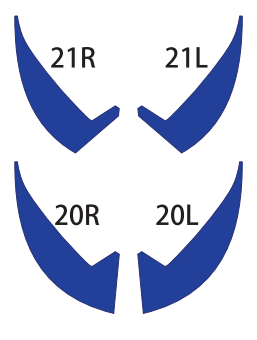

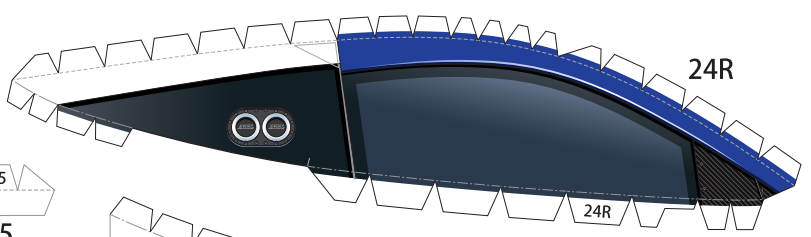
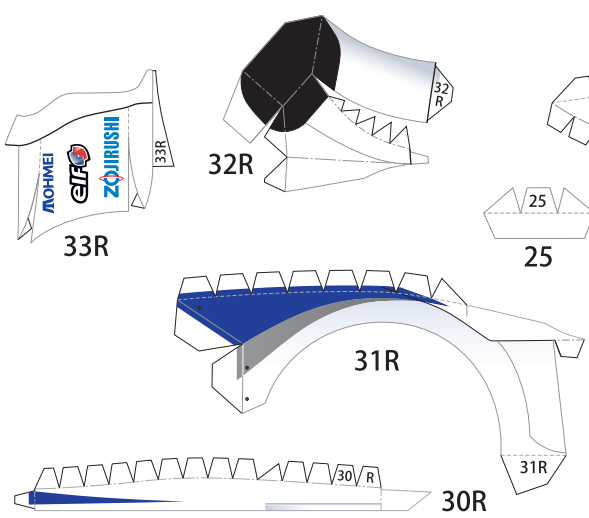
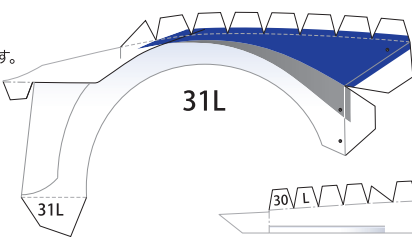
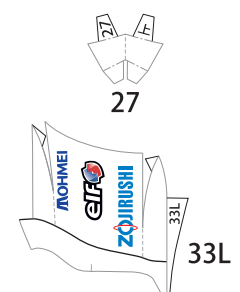
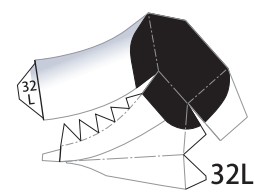
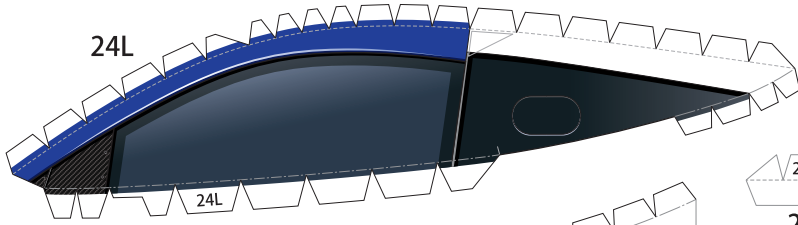
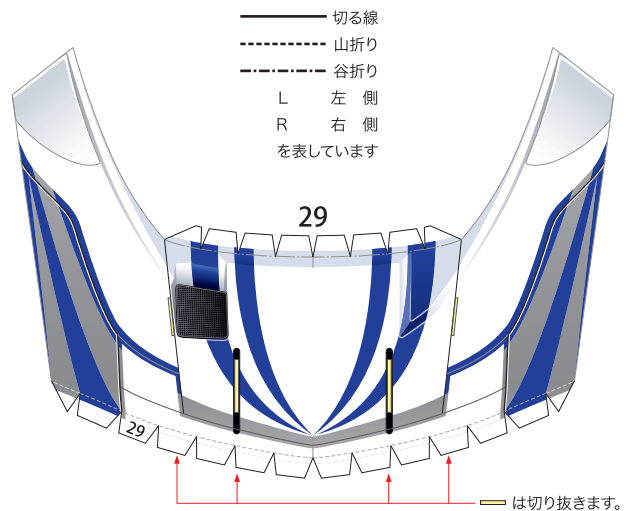
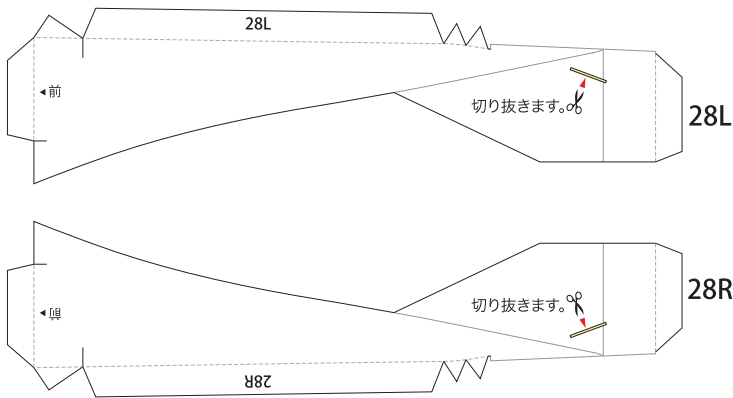
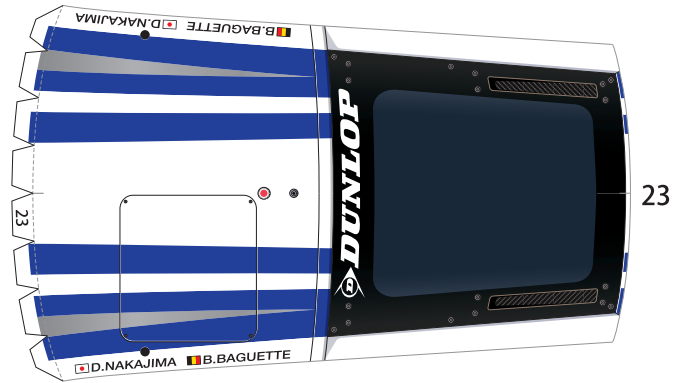
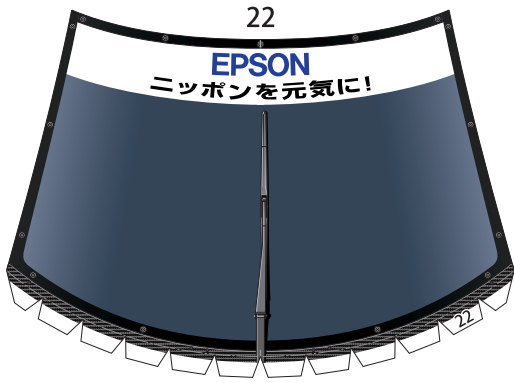

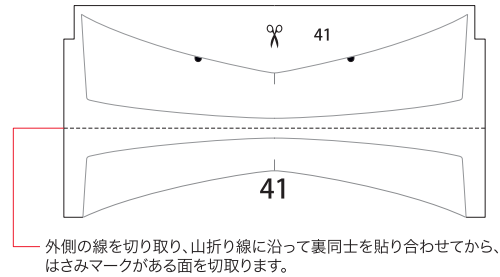
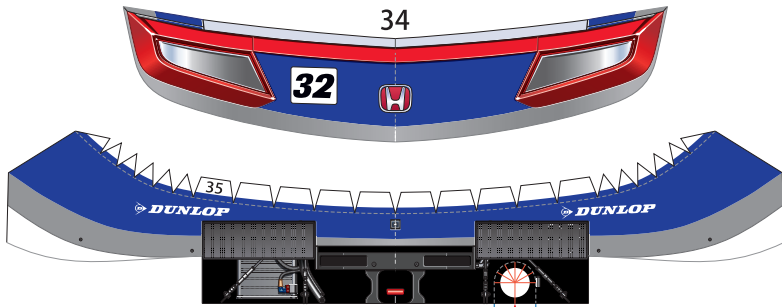

外側の線を切り取り、山折り線に沿って裏同士を貼り合わせてから、はさみマークがある面を切り取ります。

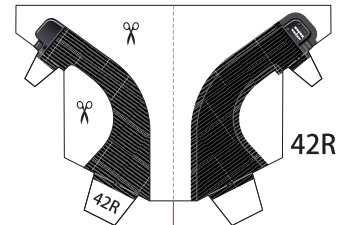
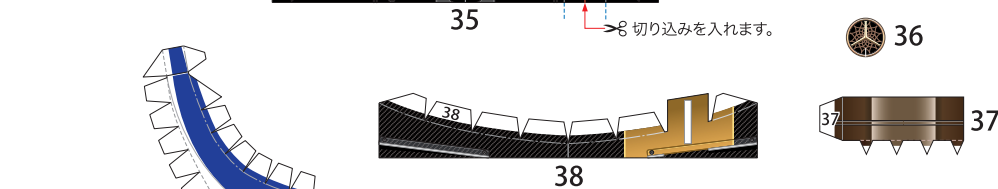

外側の線を切り取り、はみ出しているところ以外の裏同士を山折り線に沿って貼り合わせてから、はさみマークがある面を切り取ります。

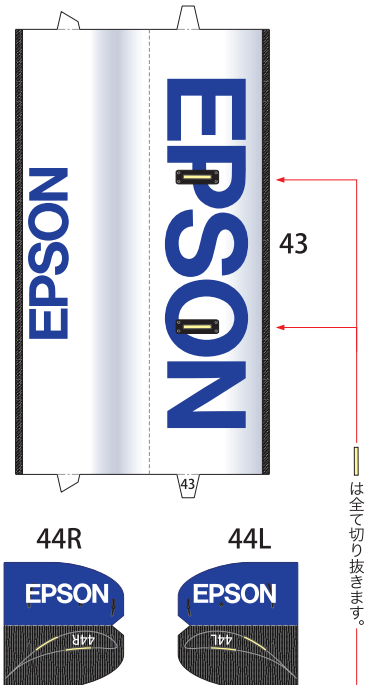
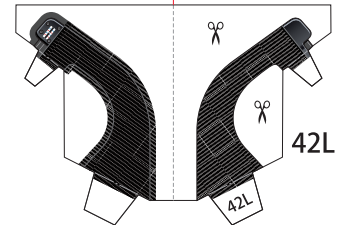
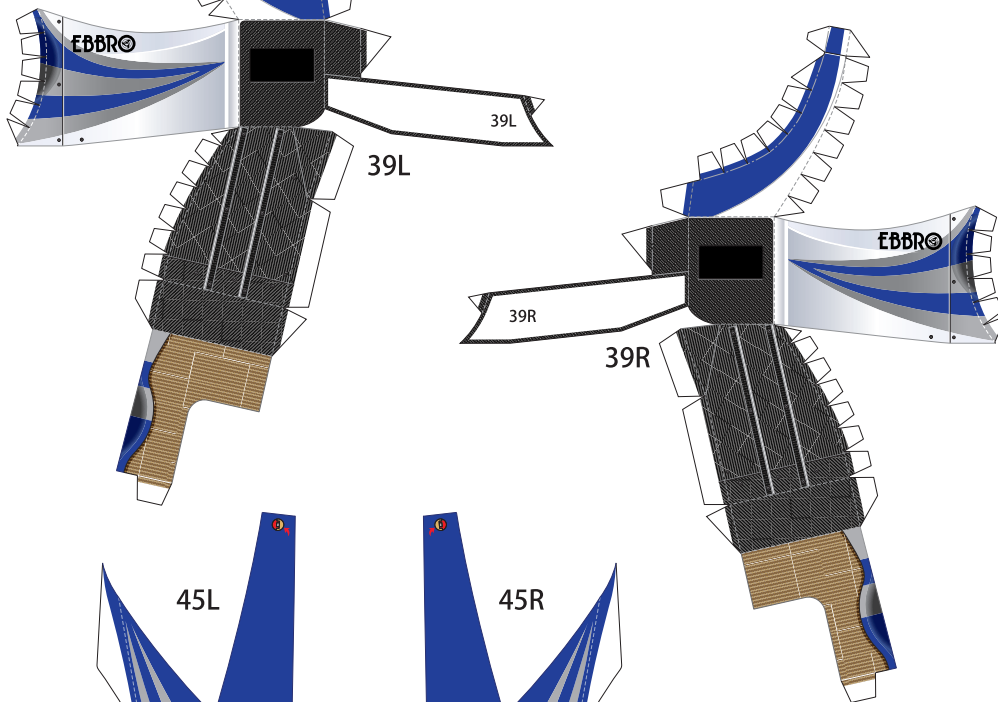

は全て切り抜きます。

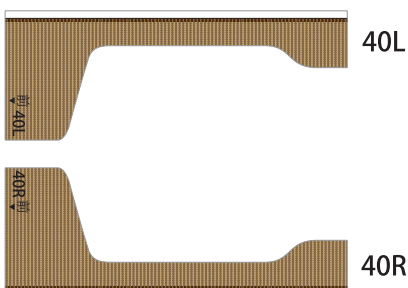
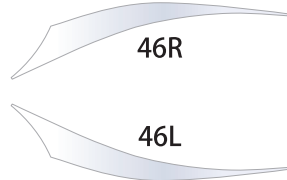

—— 切る線  
 - - - 山折り  
 - - - 谷折り  
 L 左側  
 R 右側  
 を表しています



白い点まで切込みを入れます。

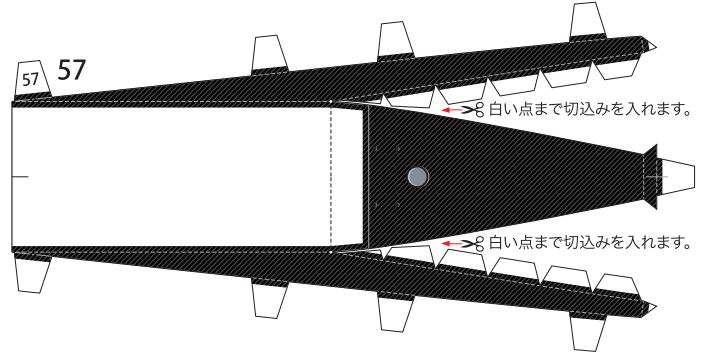
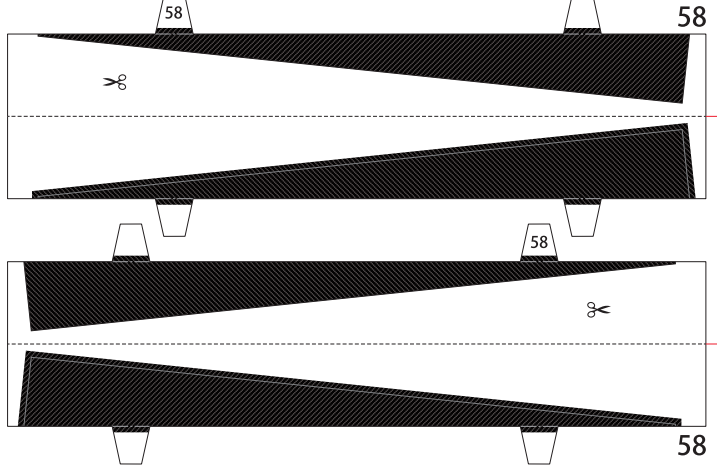
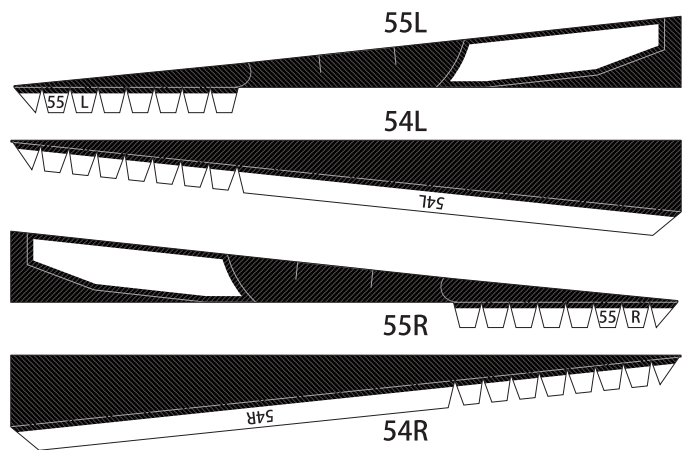
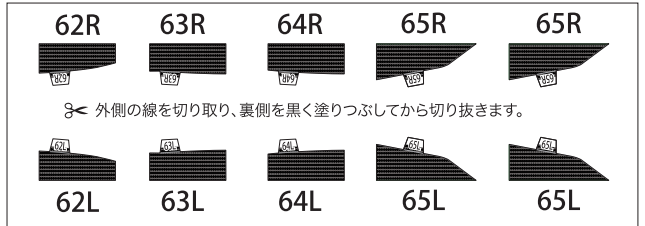
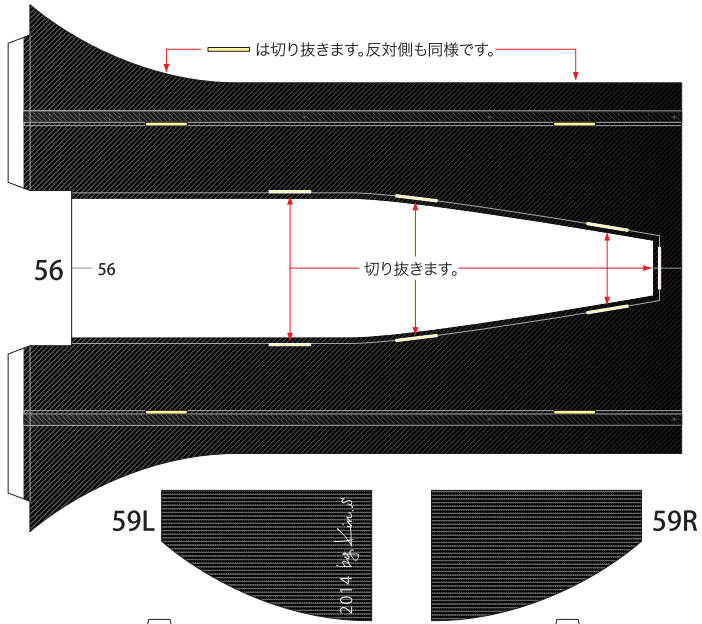
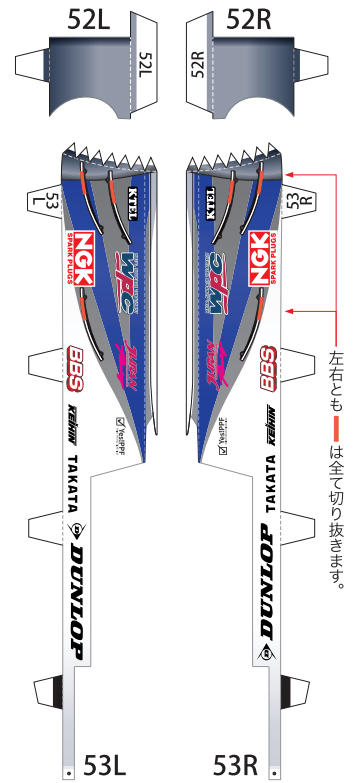
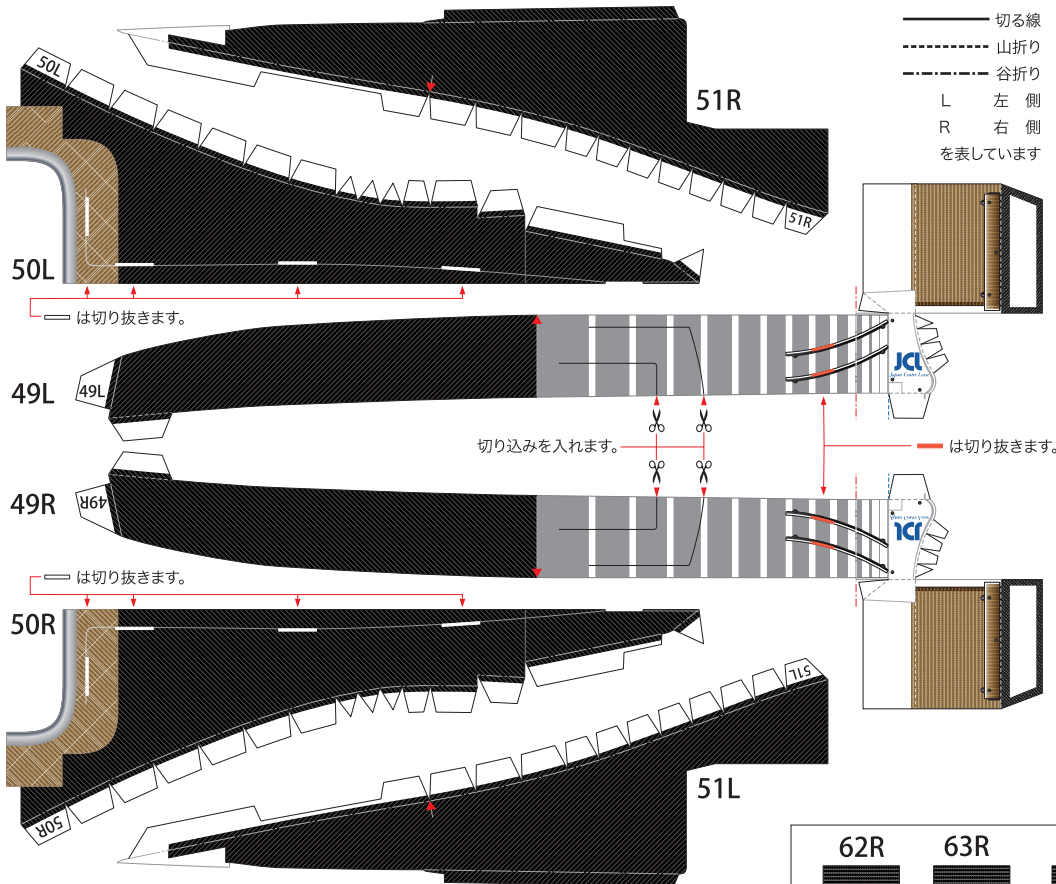

外側の線を切り取り、はみ出しているところ以外の裏同士を山折り線に沿って貼り合わせてから、はさみマークがある面を切り取ります。

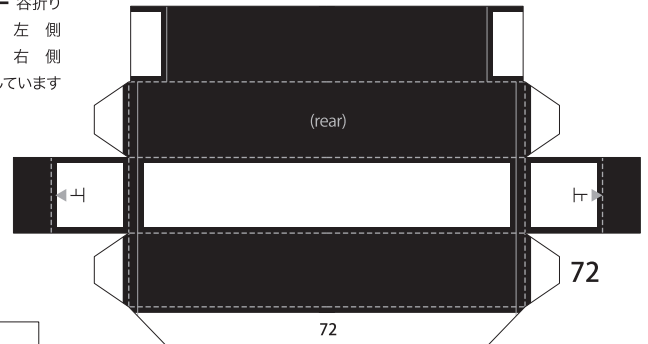
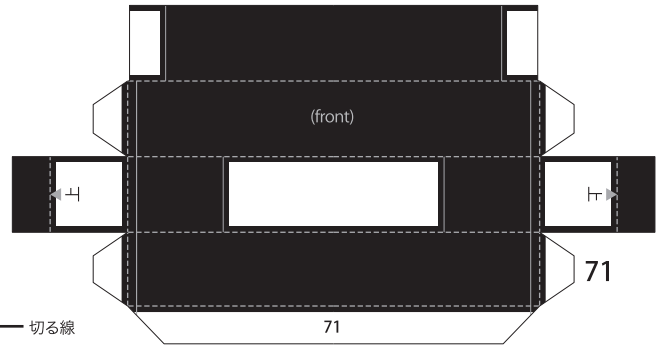
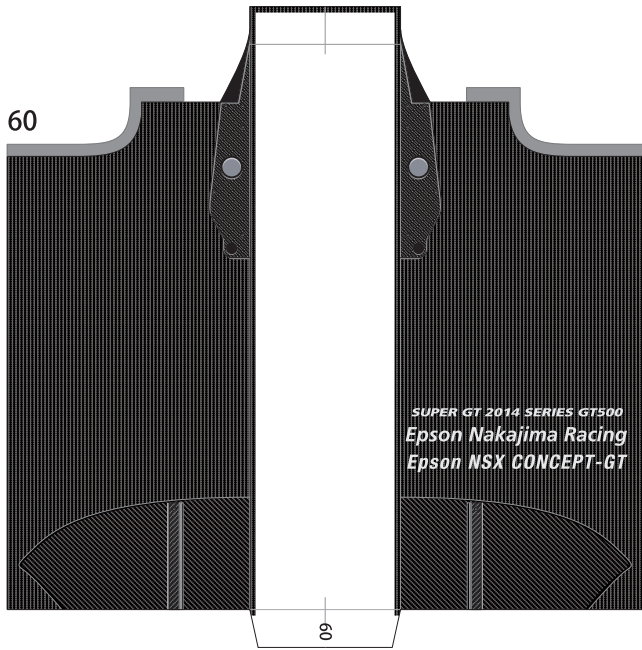

— 切る線  
 - - - 山折り  
 - - - 谷折り  
 L 左側  
 R 右側  
 を表しています

外側の線を切り取り、山折り線に沿って裏同士を貼り合わせてから、はさみマークがある面を切り取ります。

