

Modulo Nakajima Racing Modulo Epson NSX-GT

1:24 Scale Paper Craft 走る! Modulo Epson NSX-GT Sheet 1

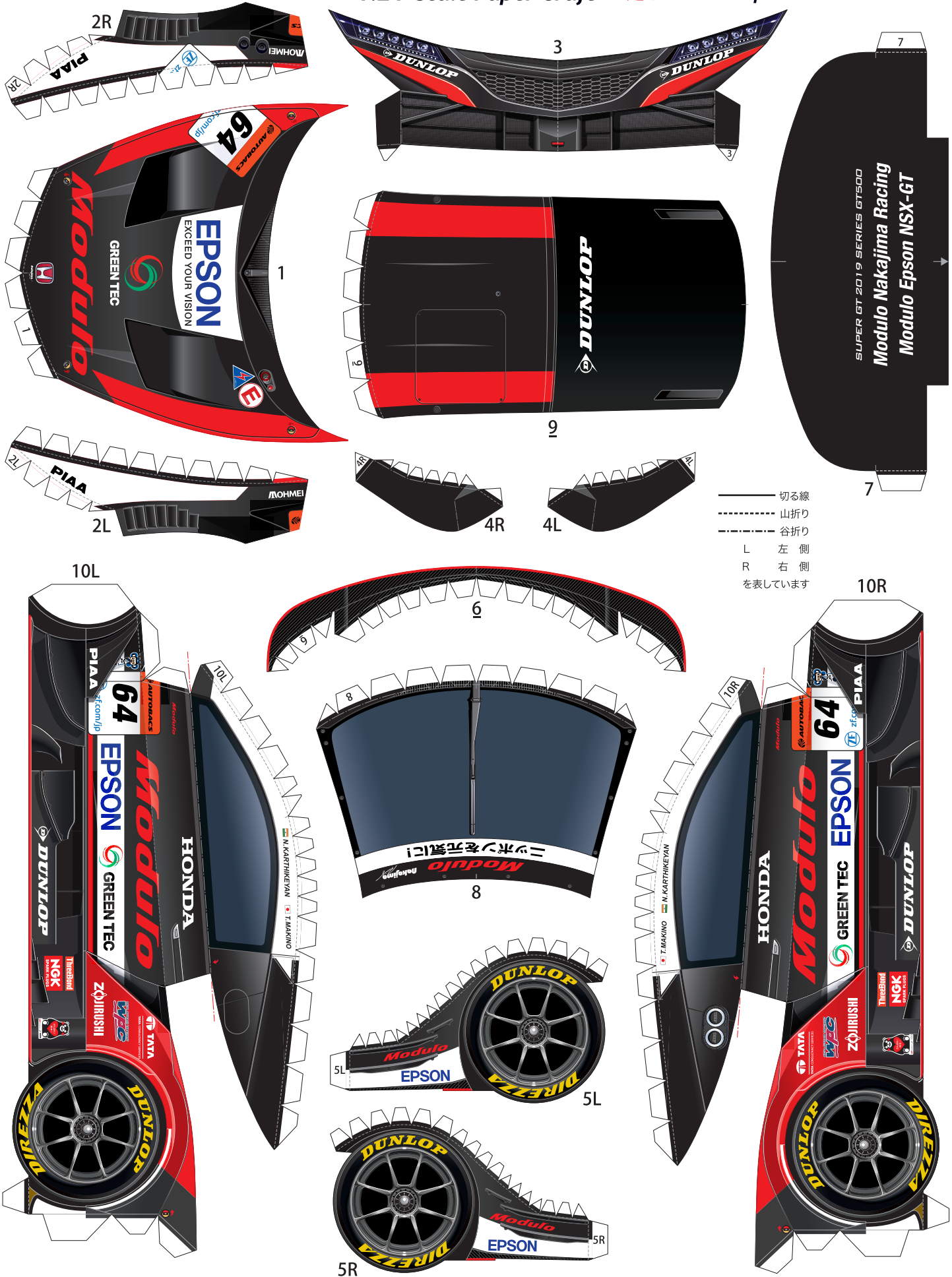

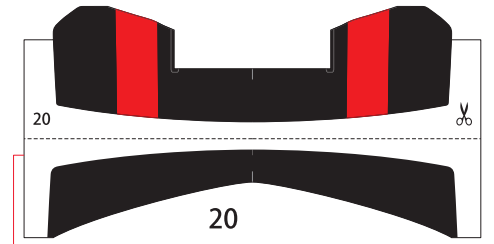
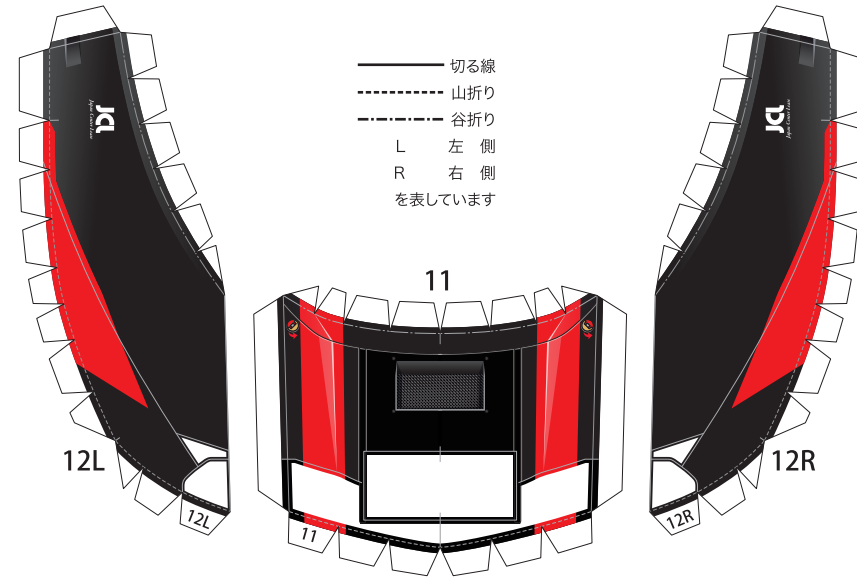

外側の線を切り取り、山折り線に沿って裏同士を貼り合わせてから、はさみマークがある面を切り取ります

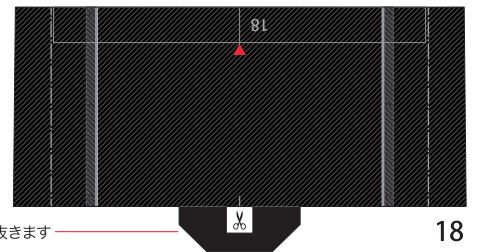
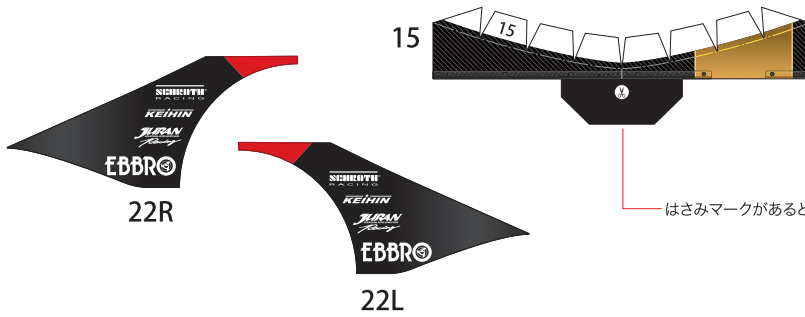
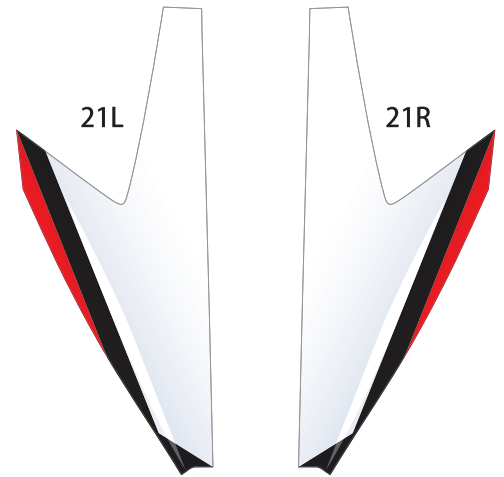
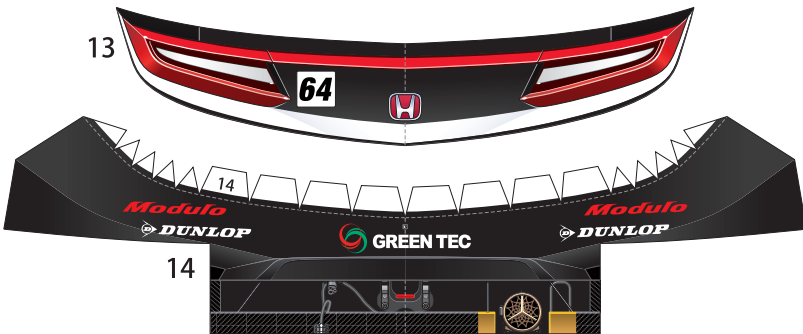

はさみマークがあるところは切り抜きます

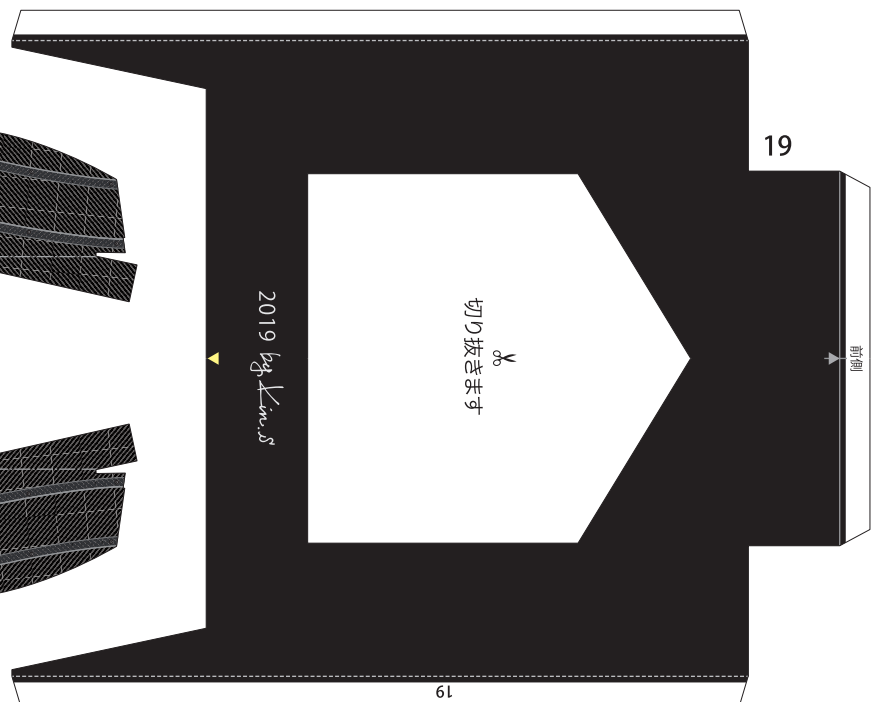
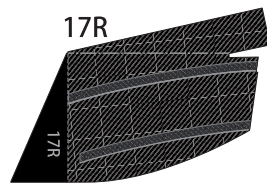
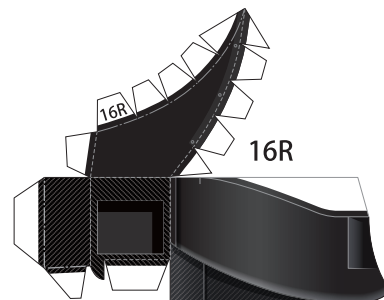
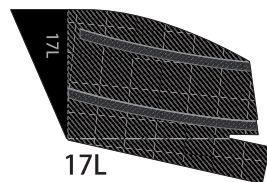
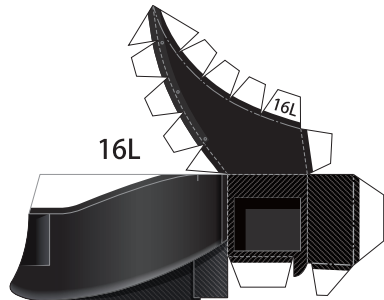

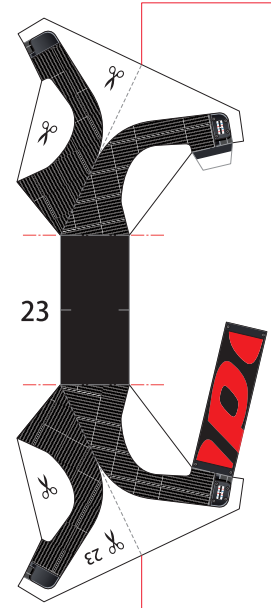
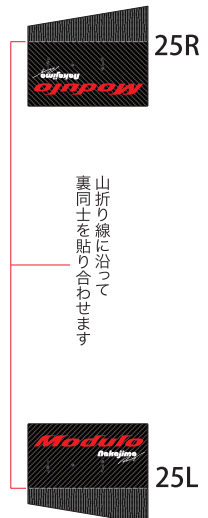
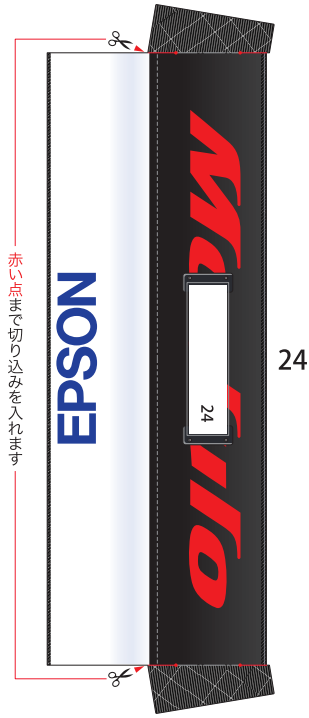

外側の線を切り取り、山折り線に沿って裏同士を貼り合わせてから、はさみマークがある面を切り取ります



— 切る線
 - - - 山折り
 - · - 谷折り
 L 左側
 R 右側
 を表しています



